

KRAIBURG Softbed LongLine

Prerequisites:



Concrete area:

- No holes
- No ridges
- Min. 3% slope

Mats:

Even temperature:
min. 5°C to max. 30°C
(store according to initial temperature)

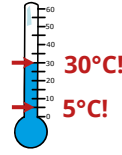

For animal well-being, a certain amount of bedding is necessary to absorb moisture (e.g. soft milled straw or mineral material)!

You will need:

Measuring:

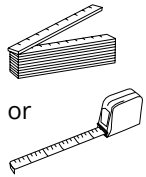

Marking:

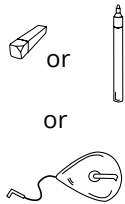

Cutting:

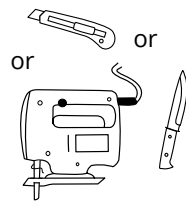

Drilling and installing:

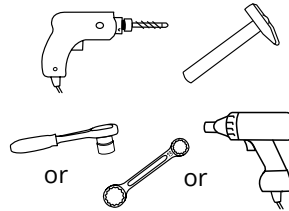

KRAIBURG fixings:

- Framing plugs \varnothing 10 x 100 mm with
 - Hexagon screws (AF 13) - A2
 - Washers \varnothing 30 mm - A2
- (Fixings are part of the delivery)



1 Placement lines

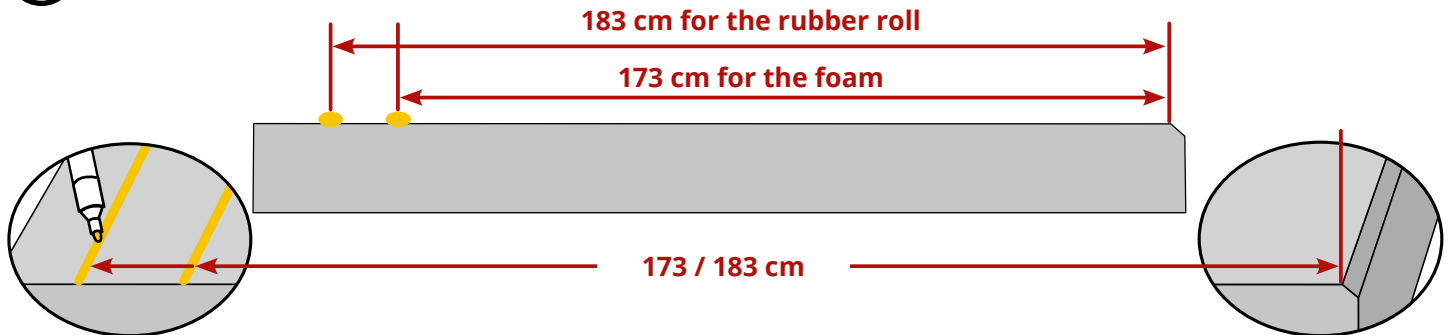

Draw placement lines at the front

Tip: Use a chalk line

Measure from the rear concrete edge

2 Install foam

- i** Align foam along the placement line 173 cm, allow space for the closure bars on the side edges (see step 5)

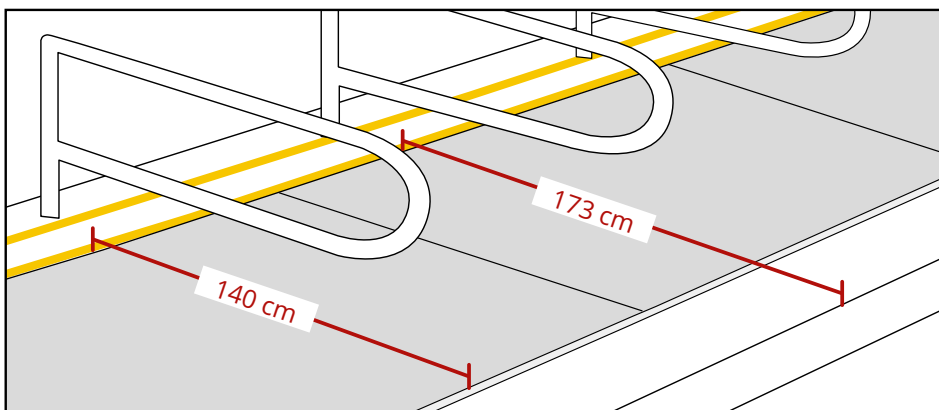

i Tip for deep dividers:

Use a wooden board as a limitation at the front edge to prevent the foam from slipping.

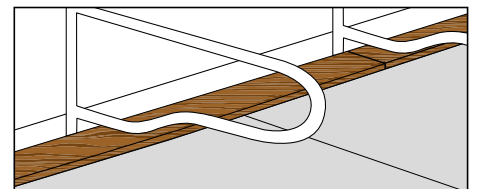

3 Roll out and position rubber flooring

Roll out rubber flooring and align it to the placement line 183 cm

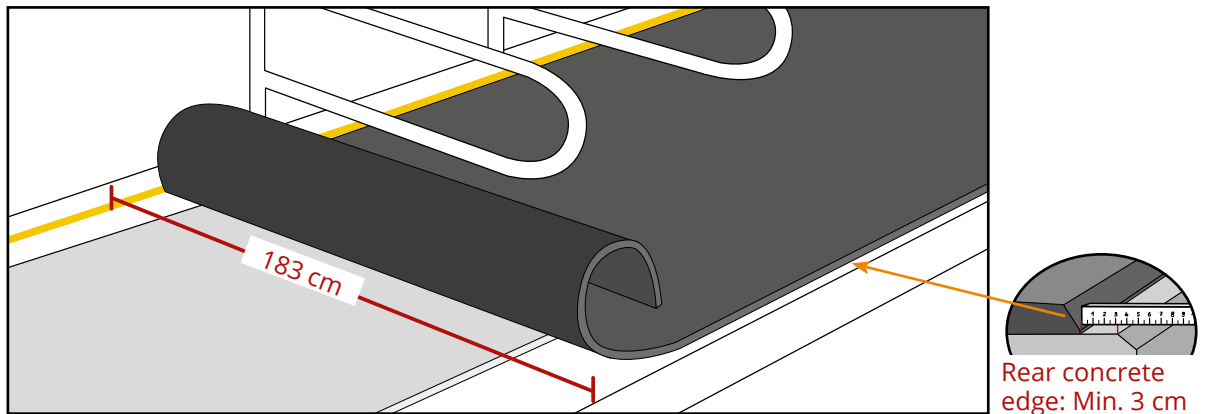

Rear concrete edge: Min. 3 cm distance!

! Cutting out pockets for pillars or the like is not possible!

4 Fix

i Start from the center of the roll and fix on the right and on the left.
Recommendation: Work from the head space to prevent the components from slipping.

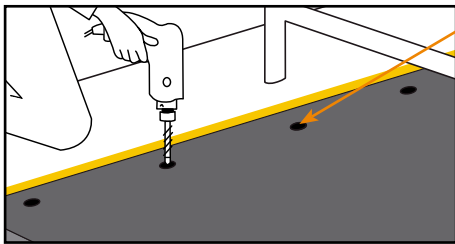

Fix at the front edge through the pre-fabricated fixing points

! Always make sure the front edge of the mat is located on the line. Re-adjust, if necessary.

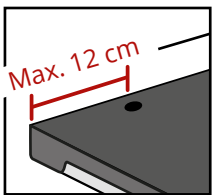

Distance between the mat edge and the outermost fixings:
Max. 12 cm!

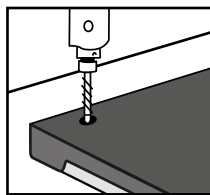

With a distance greater than 12 cm:
Place an additional fixing point

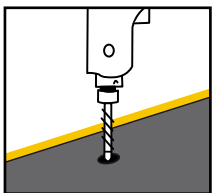

Drill

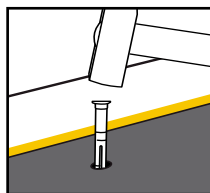

Knock the plastic plugs in flush

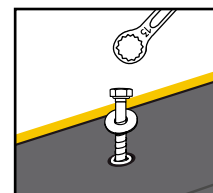

Tighten screws and washers

! Tighten screws until they are seated evenly and firmly and are slightly countersunk. **Do not overtighten!**

5 Fix side edge of the mat with a closure bar

A Position bars

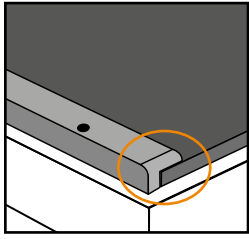

Left edge with bar

WS-L 170

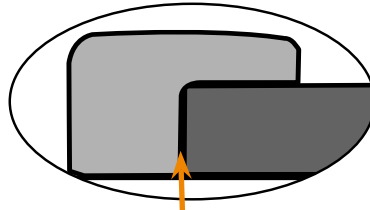

Contact

! DO NOT PRESS!

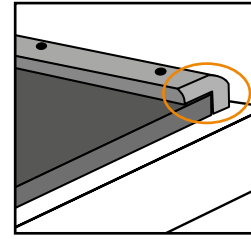

Right edge with bar

WS-R 170

- Rounded off end on the rear edge
- Flush with the rear edge of the mat

B Fix connecting bars

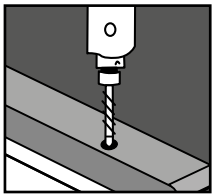

Drill

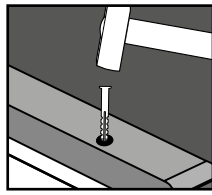

Knock the plastic plugs in flush

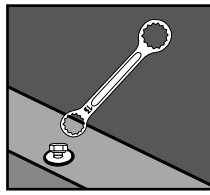

Tighten screws and washers until they are seated evenly and firmly.
Do not overtighten!



Tip:
Avoid slippage:

- Fix at one fixing point
- Then drill further holes, etc.

6 Optional: Connect two rolls with a middle bar (underneath a divider)

A Insert **WS-M 170** middle bar

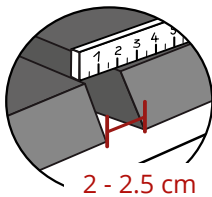

2 - 2.5 cm

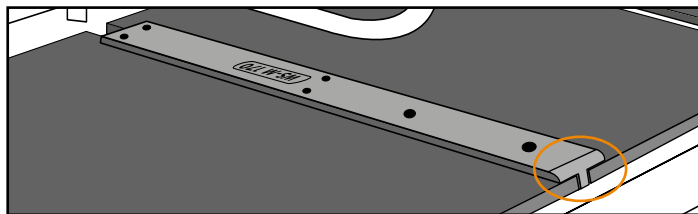

- Rounded off end on the rear edge
- Flush with the rear edge of the mat



DO NOT PRESS!

B Fix bars: See **5 B**